

Errata

Title & Document Type: 4338A Milliohmmeter User's Guide

Manual Part Number: 04338-90001

Revision Date: November 1991

HP References in this Manual

This manual may contain references to HP or Hewlett-Packard. Please note that Hewlett-Packard's former test and measurement, semiconductor products and chemical analysis businesses are now part of Agilent Technologies. We have made no changes to this manual copy. The HP XXXX referred to in this document is now the Agilent XXXX. For example, model number HP8648A is now model number Agilent 8648A.

About this Manual

We've added this manual to the Agilent website in an effort to help you support your product. This manual provides the best information we could find. It may be incomplete or contain dated information, and the scan quality may not be ideal. If we find a better copy in the future, we will add it to the Agilent website.

Support for Your Product

Agilent no longer sells or supports this product. You will find any other available product information on the Agilent Test & Measurement website:

www.tm.agilent.com

Search for the model number of this product, and the resulting product page will guide you to any available information. Our service centers may be able to perform calibration if no repair parts are needed, but no other support from Agilent is available.

HP 4338A Milliohmmeter User's Guide



日本ヒューレット・パカード株式会社
神戸事業所



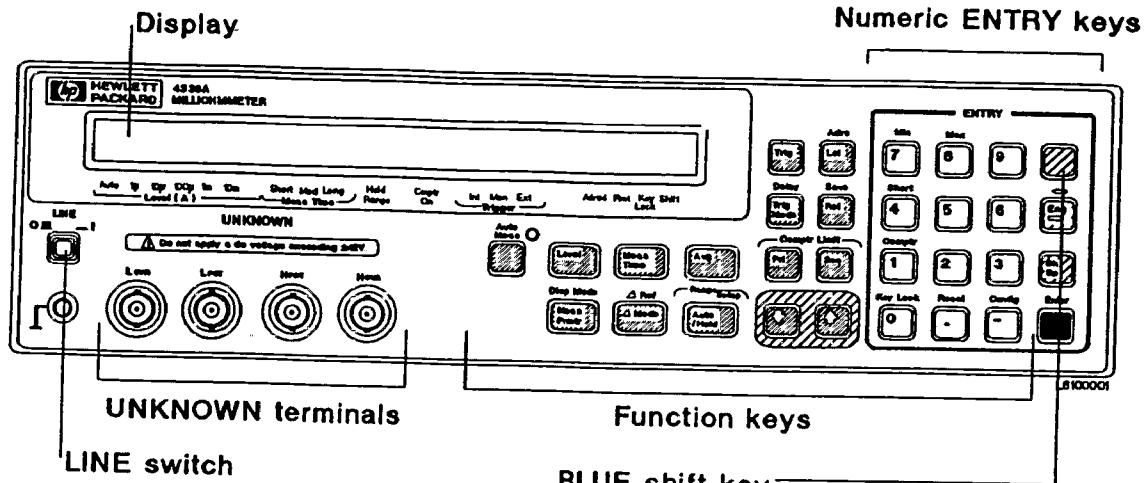

KML0258

HP 4338A Milliohmmeter at a Glance



BLUE shift key

Activates the secondary function printed in blue above the keys. For example,

Pressing   executes a SHORT correction.

(In this book, the BLUE shift key is expressed as  the top of the key is not labelled "blue".)

Annunciator (▼ marks, at the bottom of the display)

Shows the instrument's operational state. For example,

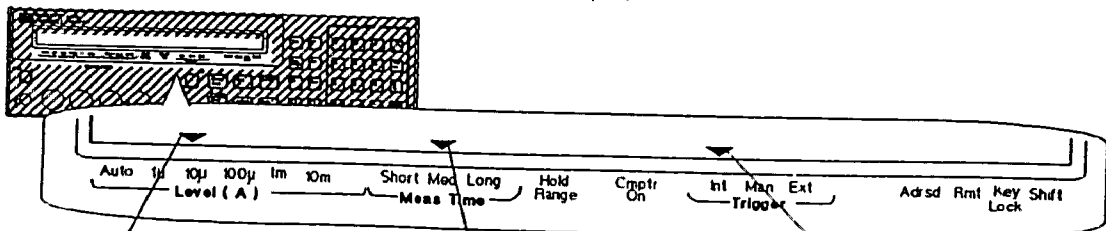





























Indicates the test level is 10 μ A

Indicates the medium measurement time mode is selected

Indicates the internal trigger mode is selected.

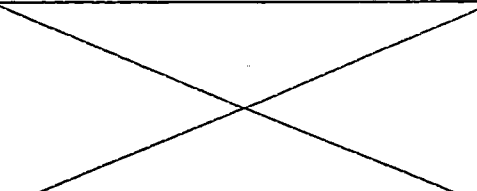
Function Keys

<p>ON/OFF indicator</p>  <p>Sets the Auto measurement function to ON. (page 2-2)</p>	 <p>Triggers a measurement in the Manual trigger mode (page 2-11)</p>	 <p>Retrieves the minimum value. (See Operation Manual)</p>
 <p>Selects the test signal level. (page 2-4)</p>	 <p>Selects the trigger mode. (page 2-6)</p>  <p>Sets the trigger delay time. (page 2-6)</p>	 <p>Retrieves the maximum value. (See Operation Manual)</p>
<p>Disp Mode</p>  <p>Selects the measurement parameter. (page 2-5)</p> <p>Disp Mode</p>  <p>Selects the display mode (page 2-9)</p>	<p>Adrs</p>  <p>Returns the HP 4338A to the local mode. (See Operation Manual)</p> <p>Adrs</p>  <p>Sets the HP-IB address. (page 2-10 or See Operation Manual)</p>	 <p>Executes a SHORT correction. (page 2-3)</p>
 <p>Selects the measurement time mode. (page 2-5)</p>	<p>Save</p>  <p>Recalls the instrument settings from internal memory. (See Operation Manual)</p> <p>Save</p>  <p>Saves the instrument settings to internal memory. (See Operation Manual)</p>	 <p>Toggles the comparator function between ON and OFF. (page 2-8)</p>
<p>ΔRef</p>  <p>Selects the deviation measurement mode. (page 2-7)</p> <p>ΔRef</p>  <p>Sets the reference value for deviation measurement. (page 2-7)</p>	  <p>Sets the comparator limit value of the primary and secondary parameters. (page 2-8)</p>	 <p>Locks out any key input except this key. (See Operation Manual)</p>
 <p>Sets the averaging rate. (page 2-5)</p>	  <p>Increases or decreases the setting value. (See Operation Manual)</p>	 <p>Resets the HP 4338A to the default settings (page 2-2)</p>
<p>Range Setup</p>  <p>Toggles the measurement range mode between Auto and Hold. (page 2-4)</p> <p>Range Setup</p>  <p>Selects the measurement range. (page 2-4)</p>		 <p>Sets the beeper mode and power LINE frequency, and executes the self test. (page 1-2, 2-9)</p>

Documentation Map

- *HP 4338A User's Guide* (HP part number 04338-90001) ← This Book
Is a handy reference to help you to get started using your HP 4338A, basic measurements and commonly used features are explained.
- *HP 4338A Operation Manual* (HP part number 04338-90000, furnished with the HP 4338A)
Provides information on initial inspection, how to operate the HP 4338A, in-depth reference information, general information, specifications, and maintenance information.
- *HP 16338A Operation and Service Manual* (HP part number 16338-90000, furnished with the HP 4338A)
Provides information on initial inspection, how to operate the HP 16338A Test Lead Set, in-depth reference information, general information, specifications, and service information.
- *HP 4338A Service Manual* (HP part number 04338-90031, Option 0B3 only)
Explains how to adjust, troubleshoot, and repair the HP 4338A.

In User's Guide

- Chapter 1, Preparation for Use
For initial turn ON of the HP 4338A
- Chapter 2, Operating the HP 4338A
Basic measurement operation
 - Getting acquainted with the HP 4338A—for beginners
 - Handy reference for common measurement tasks—for all users
- Chapter 3, Measurement Example
Measurement Examples for typical HP 4338A applications
 - Measuring Contact Resistance of a Switch
 - Measuring Internal Resistance of a Battery

In the User's Guide, information on the following subjects is not discussed:

- Initial Inspection
- HP-IB remote control
- Using with Handler
- Maintenance
- Specifications
- Error Messages

For detailed information on these subjects, see the *HP 4338A Operation Manual*.

Contents

1. Preparation for Use	
In This Chapter	1-1
Power Requirements	1-1
To Set Power LINE Voltage	1-1
To Set Power LINE Frequency	1-2
2. Operating the HP 4338A	
In This Chapter	2-1
Measurement Procedure	2-1
Let's Try—Fully Automatic Measurement	2-2
Resetting HP 4338A to its Default Settings	2-2
Connecting the Test Leads	2-2
Performing a SHORT Correction	2-3
—Canceling the residual impedance in series with the DUT	2-3
If "OUT OF LIMIT" is displayed	2-3
Measuring a DUT	2-3
Test Voltage Limit	2-3
To Set Test Level	2-4
To Select Measurement Range	2-4
Auto Range mode—Automatically selecting the optimum measurement range	2-4
Hold Range mode—Holding the measurement range of your choice	2-4
To Select Measurement Parameter	2-5
To Select Measurement Time Mode	2-5
To Set Averaging Rate—Stabilizing the measurement result	2-5
To Select Trigger Mode	2-6
To Set Trigger Delay Time	2-6
To Use Deviation Measurement Function	2-7
Setting the Deviation Reference Values	2-7
Selecting the Deviation Mode	2-7
To Use Comparator Function	2-8
Setting the Limit Values	2-8
Sorting	2-8
To Select Display Mode	2-9
To Select Beeper Mode	2-9
To Print Measurement Data	2-10
Setting the Printer	2-10
Printing	2-10
Disabling Printing	2-10
To Trigger a Measurement	2-11
If You Have a Problem	2-11
If you find yourself lost when operating the HP 4338A	2-11
If the HP 4338A does not accept key input:	2-11
If the HP 4338A displays annunciators only:	2-11
If ----- or "OVLd" is displayed:	2-11
Reference	2-12
Default Settings	2-12

Accessories Available	2-12
HP 16064B LED Display/Trigger Box	2-12
HP 16338A Test Lead Set	2-12
SHORT Configuration	2-13
Measurement Range Setting	2-14
Other Topics	2-14
3. Measurement Examples	
In This Chapter	3-1
HP 4338A Features and Benefits	3-1
Test System Configuration for a Production Line	3-1
Testing Contact of Electromechanical Devices	3-2
Measuring the Contact Resistance of a Switch	3-2
DUT	3-2
Requirements	3-2
Measurement Setup	3-2
Measurement Procedure	3-2
For More Information	3-4
Evaluating Battery Internal Resistance	3-5
Measuring a Battery Internal Resistance	3-5
DUT	3-5
Requirements	3-5
Measurement Setup	3-5
Measurement Procedure	3-5
For More Information	3-7

Figures

2-1. Measurement Procedure	2-1
2-2. Connecting HP 16338A Test Lead Set	2-2
2-3. Printer Output	2-10
2-4. SHORT Configuration for Each Test Leads	2-13
2-5. Measurement Range	2-14

Tables

1-1. Line Voltage Selection	1-1
2-1. Examples of Connecting the Test Leads and DUTs	2-13

Preparation for Use

In This Chapter

Before turning the HP 4338A ON, you must first set the HP 4338A to match the available power LINE voltage.

If the HP 4338A's power LINE voltage and frequency are properly set and ready to use, you can skip this chapter.

Power Requirements

The HP 4338A's power source requirements are as follows:

LINE Voltage : 100 / 120 / 220 / 240 V ac ($\pm 10\%$)

LINE Frequency : 47 to 66 Hz

Power Consumption : 45 VA maximum

To Set Power LINE Voltage

1. Confirm that the power cable is disconnected.
2. Slide the LINE Voltage selector on the rear panel to match the power LINE voltage which will be used (see Table 1-1).

Table 1-1. Line Voltage Selection

Voltage Selector	Line Voltage	Required Fuse
(a) 115 V	100 / 120 V	T 0.5 A 250 V (HP part number 2110-0202)
(b) 230 V	220 / 240 V	T 0.25 A 250 V (HP part number 2110-0201)

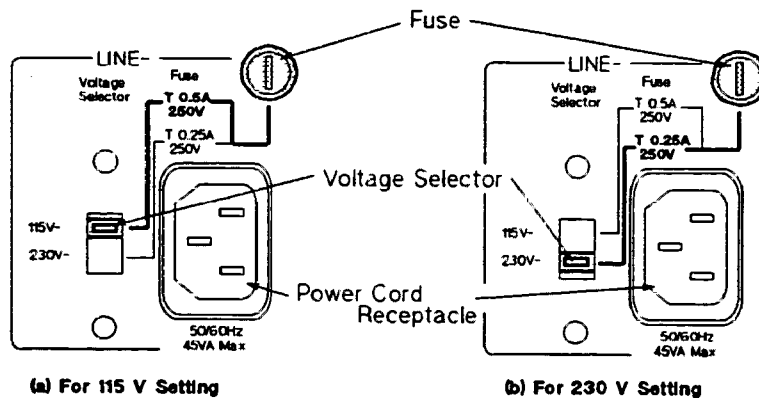

To Set Power LINE Frequency

1. Connect the power cable to the power cord receptacle on the rear panel.
2. Push the LINE switch in and the HP 4338A will emit a beep when it turns ON. All digits are displayed while the self test is in progress. (If any message is displayed, see "Error Messages" back of *HP 4338A Operation Manual*.) The HP 4338A will be ready for operation after a message like the following is displayed.

HP 4338A REV 0100



3. Press   . The following message is displayed.

BEEP LINE SVC TEST EXIT

4. Press  until "LINE" blinks, then press  .

LINE FREQ: 50HZ 60HZ

A blinking item means that it is currently selected.

5. If the setting does not match the power LINE frequency, press  to toggle the setting between "50HZ" and "60HZ".
6. Press  twice to exit this menu.

Note



The power line frequency setting is stored and is not changed after reset or power-off. Once you set it, you do not need to set the line frequency again as long as the same power line frequency is being used.

Operating the HP 4338A

In This Chapter

Basic measurement operations of the HP 4338A and references are explained.

For measurement, we use the HP 16338A Test Lead Set with the HP 4338A.

Measurement Procedure

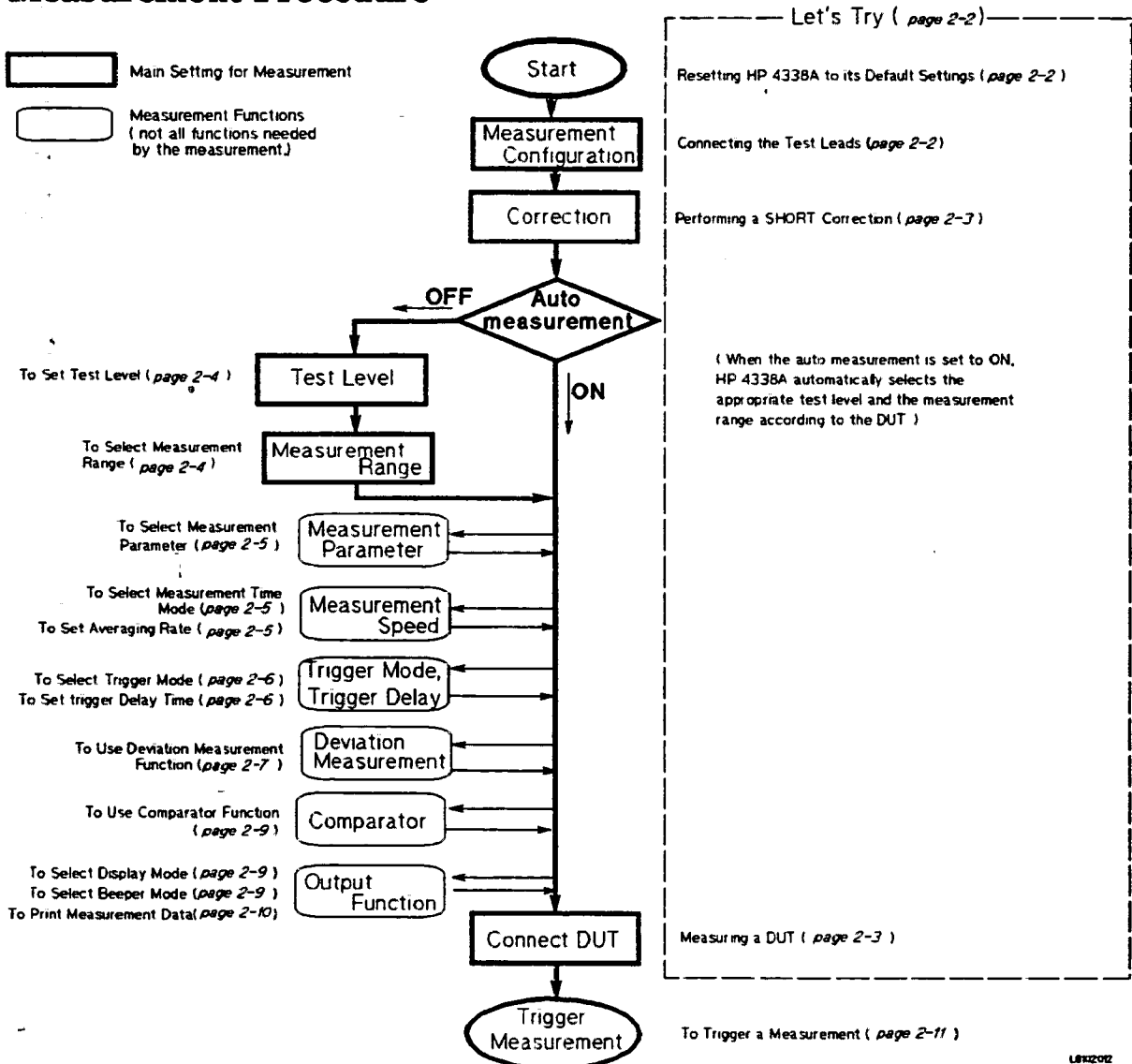



Figure 2-1. Measurement Procedure



Let's Try—Fully Automatic Measurement

The HP 4338A's auto measurement function automatically selects the appropriate test signal level and measurement range. You can measure the DUT with very simple procedure, only connecting test leads, performing a SHORT correction, and connecting the DUT.

Resetting HP 4338A to its Default Settings

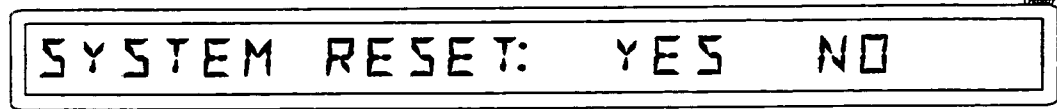
1. Press   to select the reset menu.



2. Press  until YES is blinking, then press .

The HP 4338A will be reset to its default settings. For more information about the default settings, see "Default Settings" later in this chapter.

Note



When the **auto measurement indicator** turns ON, the auto measurement function is active.

Resetting the HP 4338A, or pressing , activates the auto measurement function.

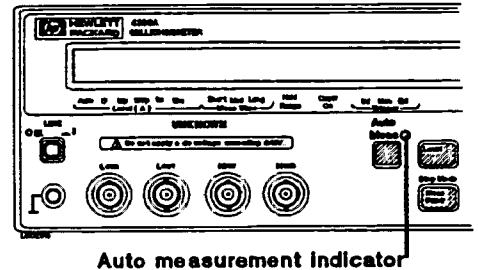

Connecting the Test Leads

Connect the test leads to the UNKNOWN terminals as follows:

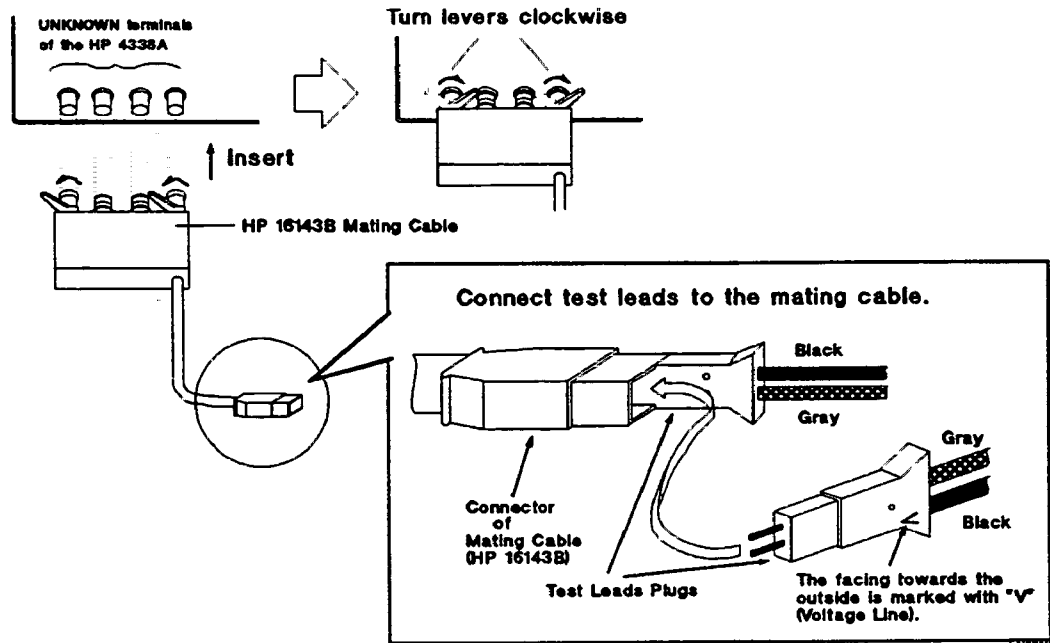



Figure 2-2. Connecting HP 16338A Test Lead Set

Performing a SHORT Correction

—Canceling the residual impedance in series with the DUT

1. Configure the test electrodes in a SHORT configuration by connecting the High and Low electrodes to each other. (For information on the SHORT configuration, see "SHORT Configuration" on page 2-13.)
2. Press   . The following message is displayed.



SHORT CORRECTION

After a while, the HP 4338A will display the SHORT correction finished message,



CORR: COMPLETE

and return to the measurement mode.

If "OUT OF LIMIT" is displayed

The SHORT impedance is so high that it would be unsuitable for SHORT correction data.

- Check that the test leads are properly connected to the UNKNOWN terminals.
- Check that the test clips are properly shorted.

And then perform the SHORT correction again.

Measuring a DUT

Connect the DUT to the test clips and the measurement result will be displayed.

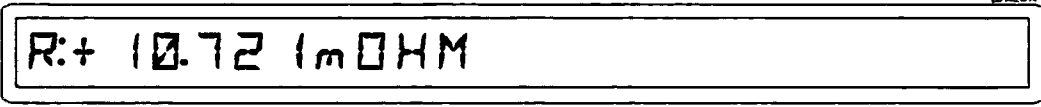

R:+ 10.72 1m0HM

Test Voltage Limit

The peak voltage across the DUT does not exceed 20 mV. (When the test voltage exceeding 20 mV, the HP 4338A disables the test voltage output and displays "OVV0L"(Over Voltage).) It prevents the test voltage from destroying the oxidation film, formed between the contacts. So, even when an unknown DUT is measured without special preparation, the contact resistance is still accurately measured without disturbing the state of the oxidation film.

To Set Test Level

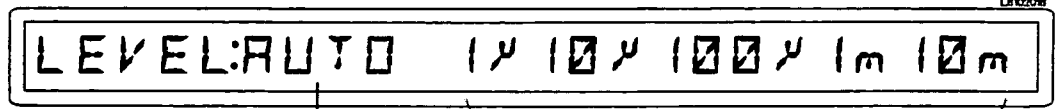

1. Press  . The level menu will be displayed.



Auto level mode :
The HP 4338A automatically selects the optimum test level.

Test signal levels (A)

The blinking level is currently selected.

2. Select the test level using .
3. Press  . The Level (A) annunciator will point to the current setting.

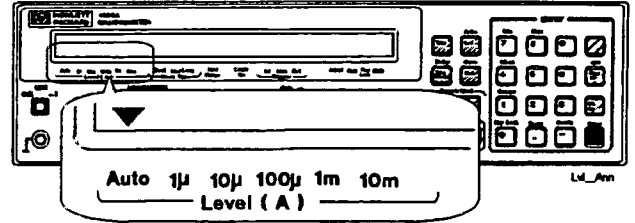

To Select Measurement Range

Auto Range mode

—Automatically selecting the optimum measurement range

- Press  . The Hold Range annunciator turns OFF.

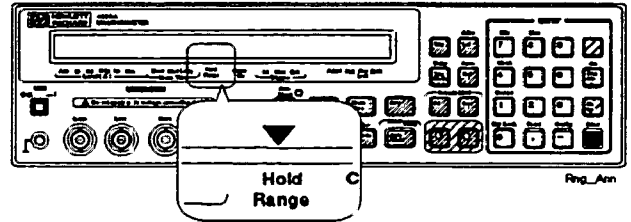



Hold Range mode—Holding the measurement range of your choice



To select the measurement range,

1. Press   . The measurement range setup menu is displayed.



2. Press  or  until the desired range is displayed. Or, input the impedance value to be measured using the numeric ENTRY keys, and the HP 4338A will select the optimum measurement range setting.
3. Press  . The Hold Range annunciator turns ON.

Note

Only pressing  or  increases or decreases the measurement range setting while a measurement is in progress.



To determine which measurement range you should select, see “Measurement Range Setting” later in this chapter.

To Select Measurement Parameter

Press  until the desired measurement parameter is displayed.

- Measurement parameter R



- Measurement parameter R-X

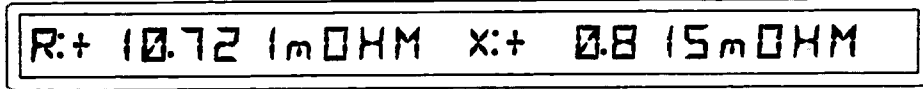

- Measurement parameter R-L (equivalent series circuit)

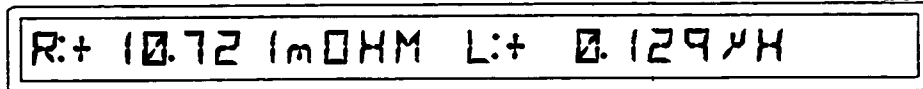

- Measurement parameter Z-∠ (phase angle)

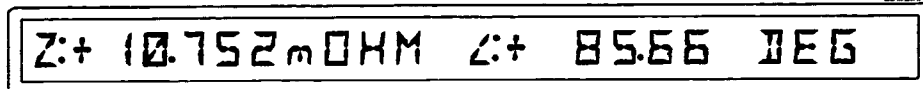

To Select Measurement Time Mode



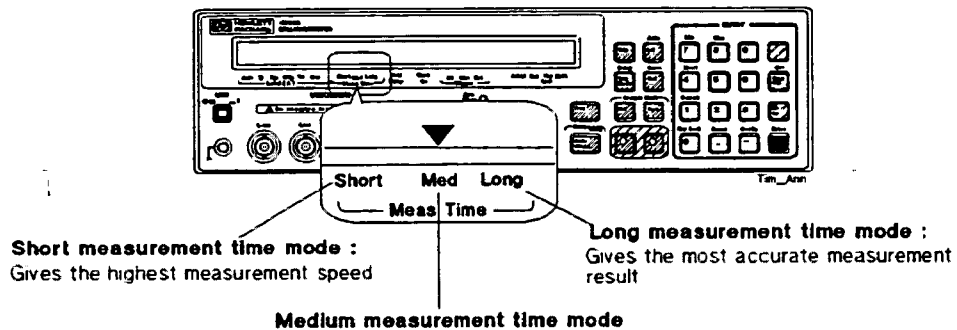

Press  until the **Meas Time** annunciator points to the desired measurement time mode.

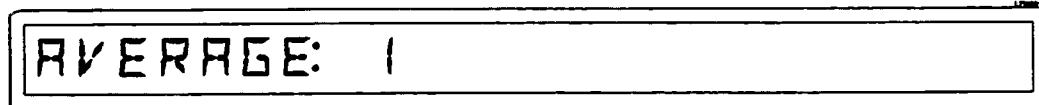

To Set Averaging Rate—Stabilizing the measurement result

1. Press  .



2. Enter the averaging rate using the numeric ENTRY keys. (For example, to enter 4, press  .) You can enter integer values from 1 to 256. Also, you can increase or decrease the value using  or .
3. Press  to set the value and to exit.

To Select Trigger Mode

Press  until the **Trigger** annunciator points to the desired trigger mode.

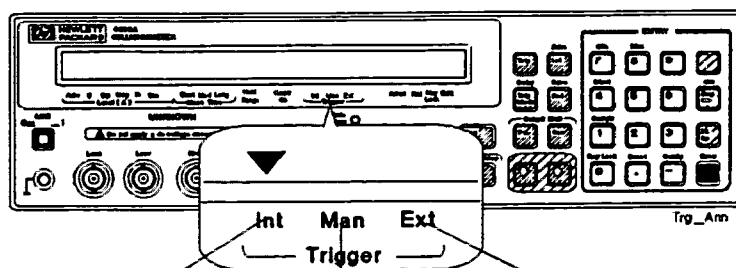

Internal trigger mode :
Free running measurement

Manual Trigger mode :
Trigger a measurement when pressing 







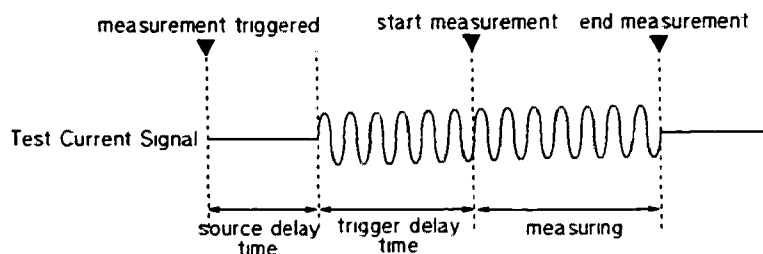
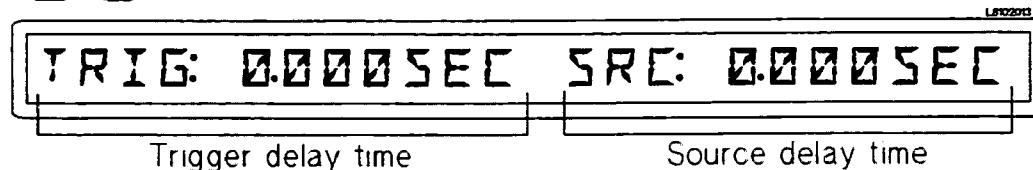

External trigger mode :
Trigger a measurement by external signal input (from an external trigger source, a handler interface, or the HP 16064B.)

To trigger a measurement in each mode, see "To Trigger a Measurement" later in this chapter.

To Set Trigger Delay Time

1. Press  .



2. A blinking TRIG: shows that you can enter the trigger delay time.
Enter the desired trigger delay time using the numeric ENTRY keys. (For example, to set 0.5 sec, press    .) You can set the trigger delay time from 0 sec to 9.999 sec.
3. Press  to set the value.
4. A blinking SRC: shows that you can enter the source delay time.
Enter the desired source delay time using the numeric ENTRY keys. (For example, to set 0.5 sec, press    .) You can set the source delay time from 0 sec to 9.999 sec.
5. Press  to set the value and to exit.



To Use Deviation Measurement Function

Setting the Deviation Reference Values

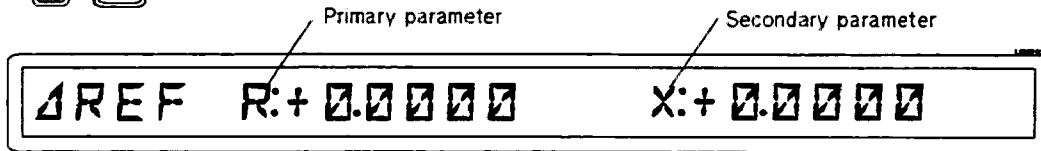
1. Press  .



The blinking parameter is a prompt to enter the reference value.

2. Select the primary or secondary parameter using  or .
3. Enter the numeric value using the numeric ENTRY keys.
4. Press  to enter the value and to exit.

Selecting the Deviation Mode

1. Press .

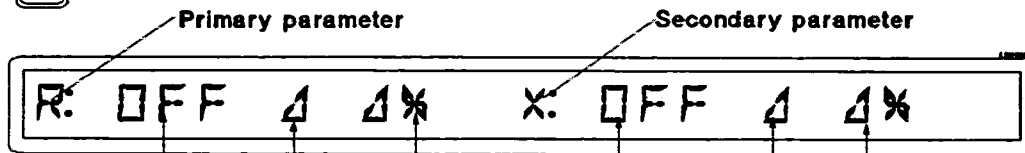





Deviation measurement OFF

Δ (Delta) mode :
(MEAS)-(REF)

$\Delta\%$ mode :
 $\frac{(MEAS)-(REF)}{(REF)} \times 100 (\%)$

(MEAS) : measurement result
(REF) : reference value

The blinking item is the mode currently selected.

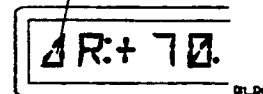

2. Select the primary or secondary parameter using  or .
3. Select the deviation mode using .
4. Press  to set the mode and to exit.

Δ is displayed in the deviation measurement mode.





To Use Comparator Function

Setting the Limit Values

1. Press  or  to select the parameter to set.

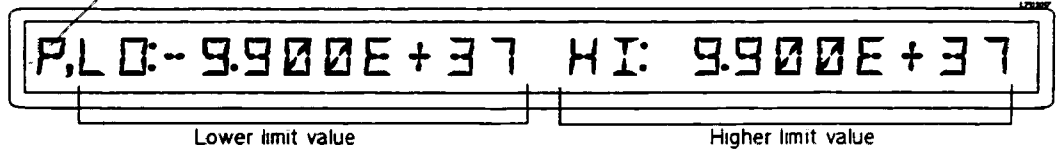
P or S stands for primary or secondary parameter.



2. A blinking L0: shows that you can enter the lower limit value. Enter the value using the numeric ENTRY keys, then press  to enter the value. You can set the value from -9.900×10^{37} to 9.900×10^{37} .
3. A blinking HI: shows that you can enter the higher limit value. Enter the value using the numeric ENTRY keys, then press  to enter the value and to exit. You can set the value from -9.900×10^{37} to 9.900×10^{37} .

Sorting

To start sorting,

Press  . The Comptr On annunciator turns ON.

To abort sorting,

Press  . The Comptr On annunciator turns OFF.

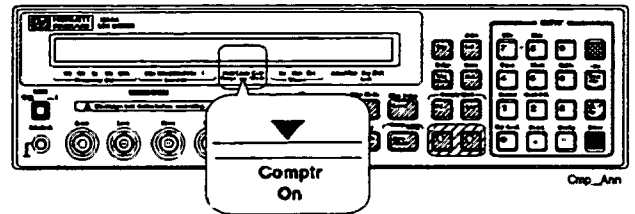

The sorting results are HIGH, IN, and LOW.



Where,

HIGH greater than higher limit
 IN between higher limit and lower limit
 LOW less than lower limit

The HP 4338A shows the comparison results using the display, beeper, printer, and HP 16064B LED Display/Trigger Box. (To use the HP 16064B, see "Accessories Available" later in this chapter.)

- For result output to the display, see "To Select Display Mode" in the next page.
- For result output to the beeper, see "To Select Beeper Mode" later in the next page.
- For result output to the printer, see "To Print Measurement Data" later in this chapter.

To Select Display Mode

Press   until the desired display is displayed. The following modes are available.

- The Measurement Display mode shows the measurement data:

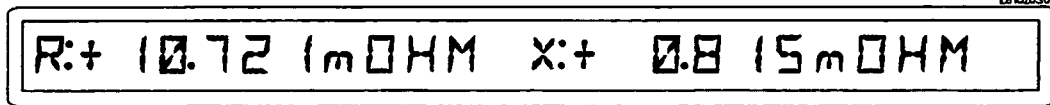

- The Comparison Display mode shows the comparison results:

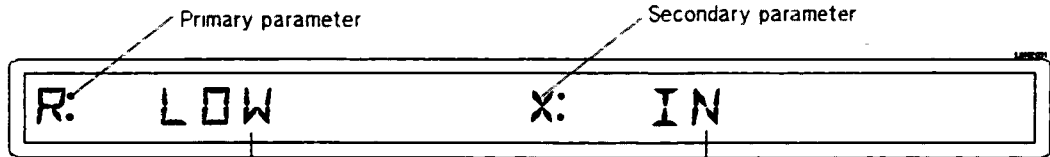

OFF : Comparator is OFF. IN : Between higher limit and lower limit.
 HIGH : Greater than higher limit. LOW : Less than lower limit.

- The Limit Table modes (two modes: one for the primary parameter and another for the secondary parameter) shows the comparator limits:

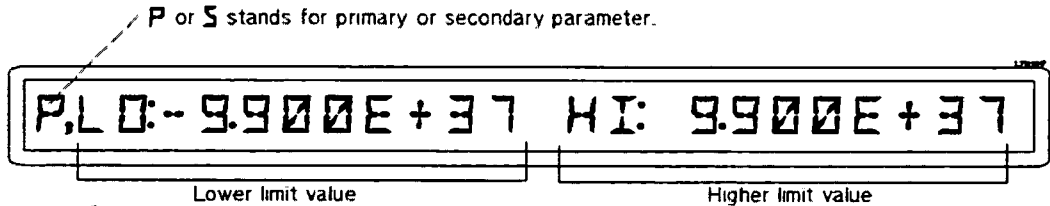

- The Display OFF mode shows the annunciators only.

To Select Beeper Mode



To change the beeper mode for the comparator result reporting:

1. Press  .

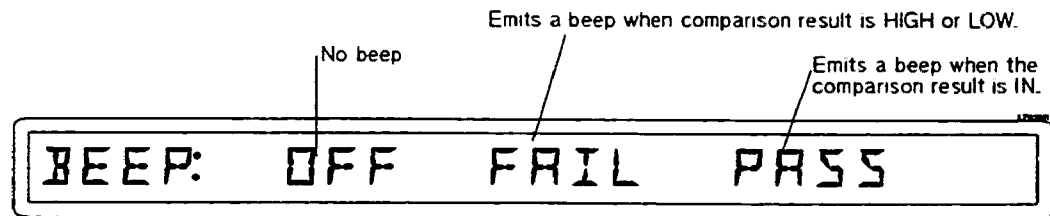

2. Select BEEP using  or  and press  to select.



3. Select the beeper mode using  or , and press  to exit to the previous display.

4. Select EXIT using  or , and press  to exit.

To Print Measurement Data

Setting the Printer

1. Use an HP-IB compatible printer, set to the listen-always mode.
2. Connect the printer to the HP 4338A's HP-IB port on the rear panel.
3. Turn the printer ON.

Printing

Set the HP 4338A to talk only mode (Set the HP 4338A's HP-IB address to 31).

1. Press   **3** .

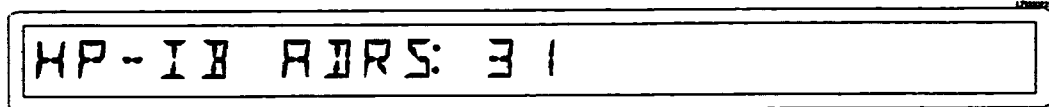

2. Press . The Addrsd annunciator turns ON and the printer begins printing the measurement data.

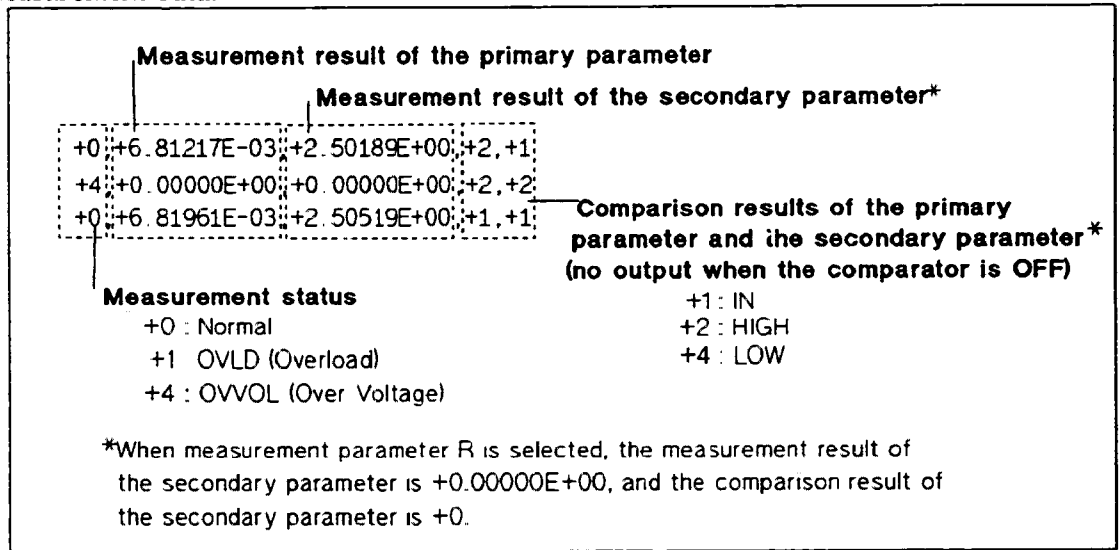



Figure 2-3. Printer Output

Disabling Printing

Change the HP-IB address to an address other than 31 (for example, 17, which is the default setting).

- Press    **1**  **7** .

To Trigger a Measurement

- In internal trigger mode—The HP 4338A makes continuous free-running measurements.
- In manual trigger mode—Press  when you want to trigger a measurement.
- In external trigger mode— Connect the external trigger source to the EXT TRIGGER terminal on the HP 4338A's rear panel, and apply a TTL level trigger signal to trigger a measurement. (For details, see the *HP 4338A Operation Manual*.)
Note that the HP 4338A must be set to the external trigger mode to be triggered from an external handler or from the HP 16064B LED Display/Trigger Box.

If You Have a Problem

If any of the problems listed below occur, follow the instructions given for the problem.

If you find yourself lost when operating the HP 4338A



You can get back on track by:

To return to the measurement mode Press  several times.

To return to the default settings Press  . (If the reset is not accepted, confirm that the **key Lock** annunciator is turned ON. See next.)

If the HP 4338A does not accept key input:

□ Check whether or not the **Key Lock** annunciator is ON. If so:



□ Press  . The **Key Lock** annunciator turns OFF and the front-panel keys are unlocked.

□ Check that the HP 16064B LED display/trigger box is connected to the HP 4338A and it is set to lock out the keys. If so, unlock the keys from the HP 16064B.

If the HP 4338A displays annunciators only:

The display mode is set to the Display OFF mode.

1. If the HP 4338A is in the key lockout mode, cancel the key lockout mode. (See previous description.)

2. Press   to change the display mode to a mode other than Display OFF.

If ----- or "OVLD" is displayed:

The measurement result is out of the measurable range. Check the DUT and make sure the measurement range is properly set.

Reference

Default Settings

- Auto measurement : ON
(Auto level, auto range mode)
- Measurement parameter : R
- Deviation measurement : OFF
- Measurement time : MEdium
- Averaging rate : 1
- Trigger mode : Internal
- Trigger delay time : 0 ms
- Source delay time : 0 ms
- Comparator : OFF
- Display mode : Measurement mode
- Beep mode : FAIL mode
- SHORT correction data is cleared

Accessories Available

HP 16064B LED Display/Trigger Box

The HP 16064B LED Display/Trigger Box triggers a measurement when its trigger key is pressed, and displays the comparison results using LEDs. It allows you to manually operate the comparator function of the HP 4338A.

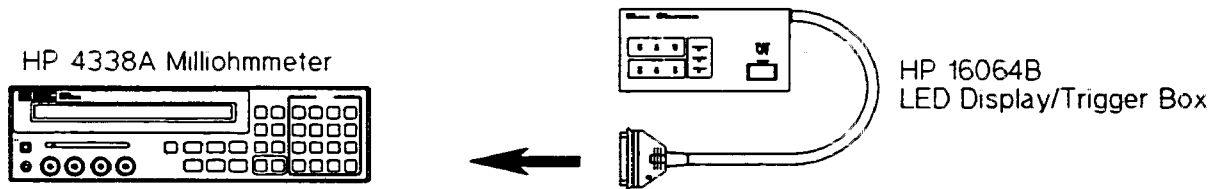

Connect to the Handler Interface connector on the rear panel.

HP 16338A Test Lead Set

Four types of test leads are available for the HP 4338A for various forms of DUTs.

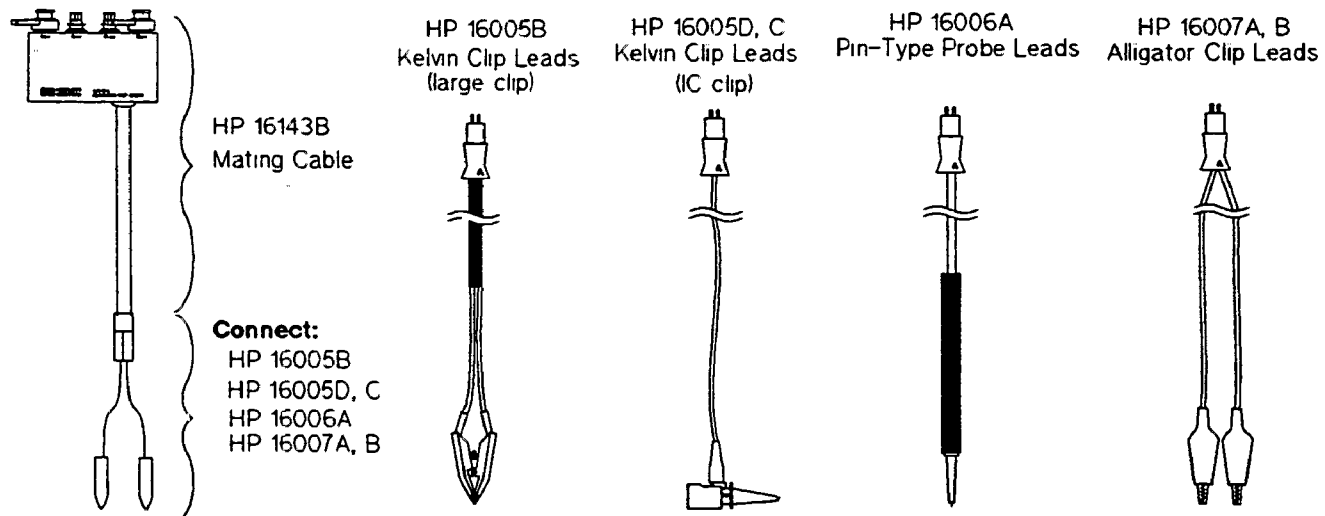
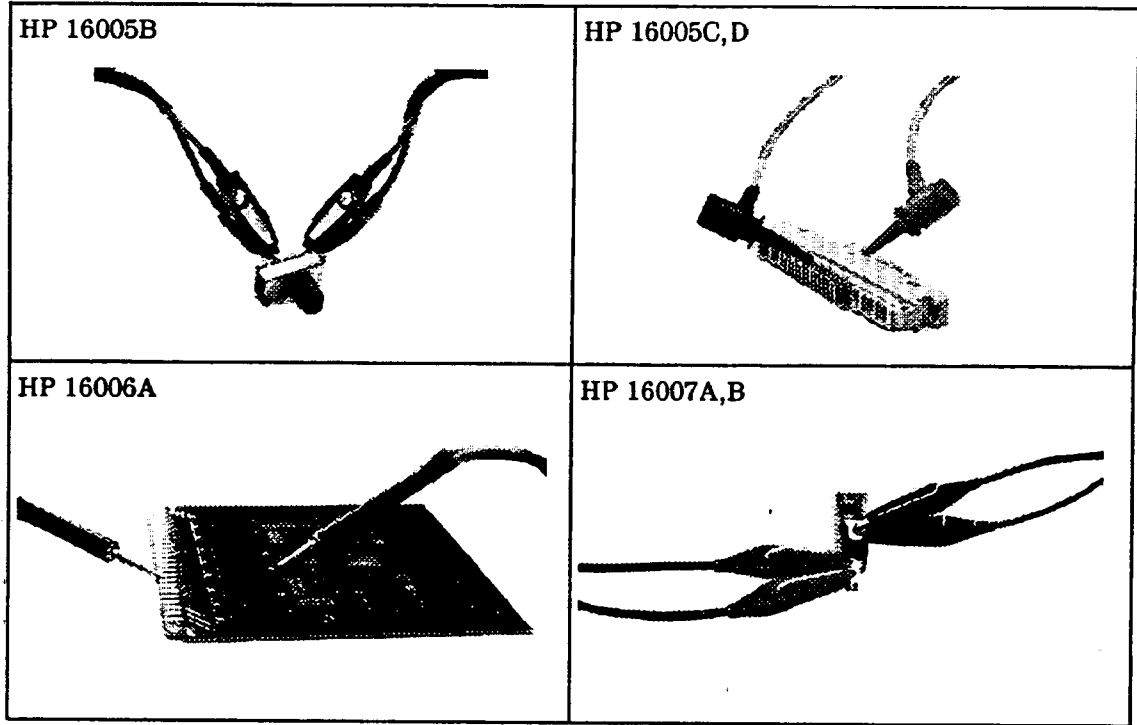

Table 2-1. Examples of Connecting the Test Leads and DUTs



Note



In addition to using two of the same types of test leads for a measurement, as shown in the above figure, you can use two different types of test leads together.

SHORT Configuration

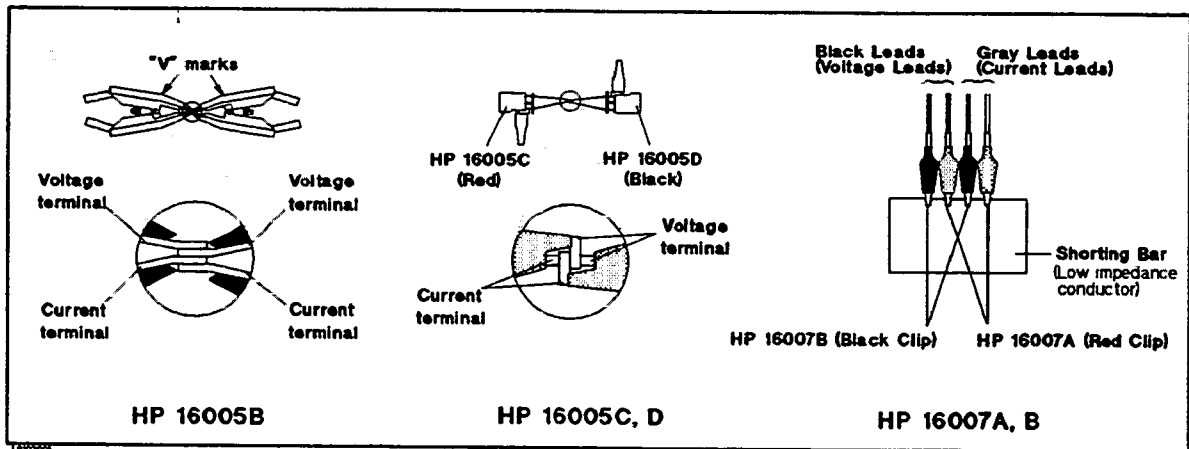

Figure 2-4. SHORT Configuration for Each Test Leads

DO NOT perform the SHORT correction when using the HP 16006A Pin-type Probe, or two test clips of different types. (It is difficult to achieve effective SHORT impedance.)

Measurement Range Setting

The available measurement range settings are 1 m Ω , 10 m Ω , 100 m Ω , 1 Ω , 10 Ω , 100 Ω , 1 k Ω , and 10 k Ω , and the range settings are limited by test level setting. See Figure 2-5.

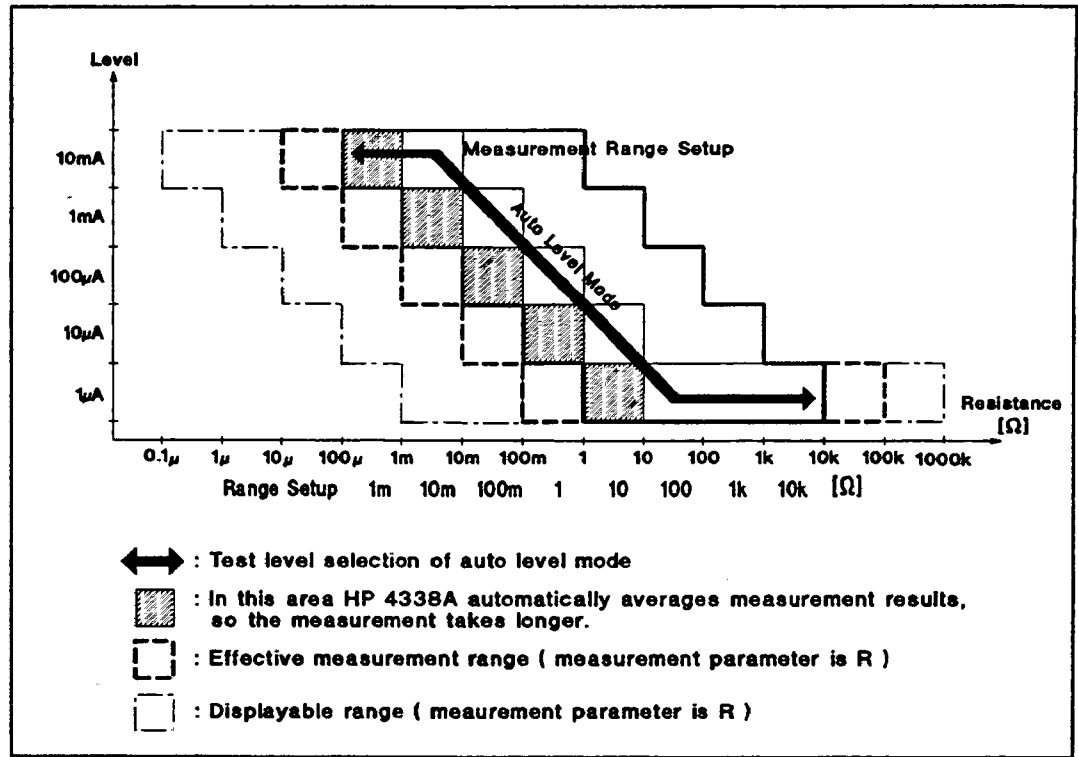

Figure 2-5. Measurement Range

Other Topics

For details on these functions, see the *HP 4338A Operation Manual*.

- Initial Inspection — Chapter 1 of the *Operation Manual*
- Key Lock Function — Chapter 2 and Chapter 3 of the *Operation Manual*
- HP-IB — Chapter 4 and Chapter 5 of the *Operation Manual*
- Handler Interface — Chapter 3, Chapter 6, and Appendix B of the *Operation Manual*
- Save / Recall — Chapter 2 and Chapter 3 of the *Operation Manual*
- Backup Function — Chapter 3 of the *Operation Manual*
- Specification — Chapter 8 of the *Operation Manual*
- Maintenance — Chapter 9 of the *Operation Manual*
- Error Messages — “Error Messages” in back of the *Operation Manual*

Measurement Examples

In This Chapter

The HP 4338A's features and benefits are discussed, which you can investigate by trying the typical measurement examples described in this chapter.

HP 4338A Features and Benefits

HP 4338A Milliohmmeter is a precise, reliable, and high speed test tool for measuring low resistance.

High quality testing

- Remove parasitics with error correction
- Consistent results with 0.4 % basic accuracy
- Resolve data to five digits

Fast test system throughput

- High speed measurement: 34 ms
- Built-in comparator
- Built-in handler-interface
- HP-IB interface standard

Versatile measurement

- Five impedance parameters (R, X, L, Z, θ)
- 1 μ A, 10 μ A, 100 μ A, 1 mA, and 10 mA test levels (1 kHz)
- Wide measurement range: 10 $\mu\Omega$ to 100 k Ω
- Four types of test leads available
- Reduce test complexity with auto measurement function
- Voltage protection on UNKNOWN terminals : 42 V_{max}
- Cable extension — 2 meters maximum

Test System Configuration for a Production Line

The HP 4338A's handler interface outputs signals to indicate measurement completed, and PASS/FAIL judgments of the comparator function. The handler interface has an input for an external trigger signal and a keylock signal. Using these signals, the HP 4338A can easily be combined with a component handler and a system controller to fully automate component testing, sorting, and quality control data processing to increase production efficiency.

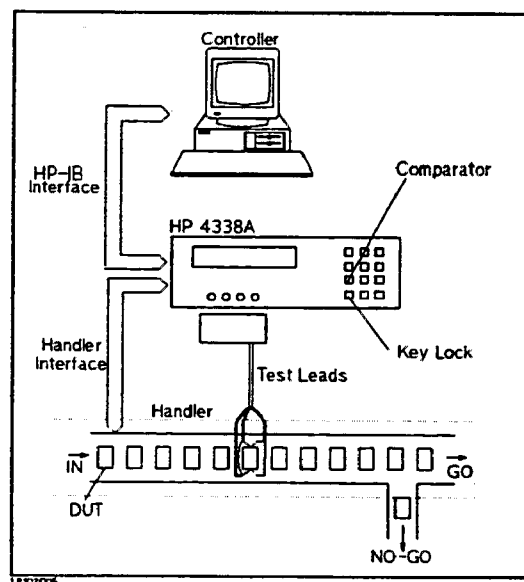

Testing Contact of Electromechanical Devices

Contact failure of electromechanical devices in low current circuits is a key issue in determining reliability of these components. The HP 4338A offers selectable low level ac test signals (1 μ A to 10 mA), so now low current conditions can be characterized. A high resolution of 5-digit measurement results allow you to determine the slightest differences in contact resistance of devices. The ac (1 kHz) test signal eliminates potential errors introduced by thermo-electric effects across the DUT contacts.

■ Auto Measurement Mode

When performing gross continuity testing where the test signal level is not a significant factor in the test, the auto measurement function allows the HP 4338A to select the appropriate test signal level and measurement range.

■ Test Voltage Limit

If the peak voltage across the DUT exceeds 20 mV, the HP 4338A disables the test voltage output. This function prevents the test signal voltage applied across the DUT from disturbing the state of the oxidation film formed between the contacts.

Measuring the Contact Resistance of a Switch

This example shows the procedure to measure contact resistance of switch. Using the auto measurement function reduces the test measurement complexity due to selecting the test level and measurement range according to the DUT.

DUT

Switch

Requirements

- Test Fixture :
- HP 16143B Mating cable
 - HP 16005C IC Clip Leads (red clip)
 - HP 16005D IC Clip Leads (black clip)

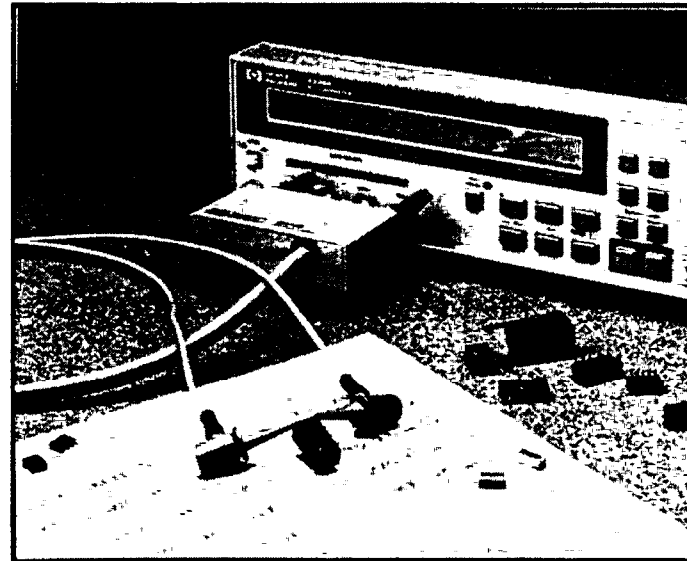

Measurement Setup

- Measurement parameter : R
- Use Auto Measurement Mode (Auto level, Auto measurement range)

Measurement Procedure

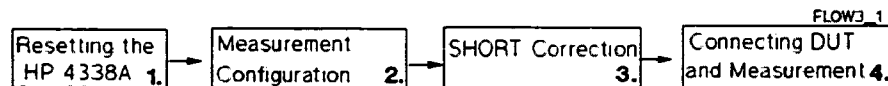



1. Reset the HP 4338A.

- a. Press  .

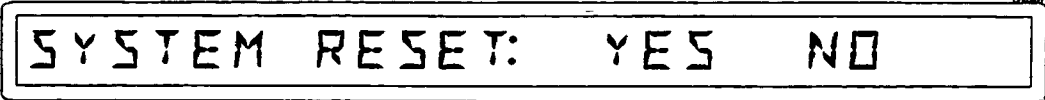
3-2 Measurement Examples



b. Press  until YES blinks, and press .

2. Connect test fixture to the UNKNOWN terminals as follows:

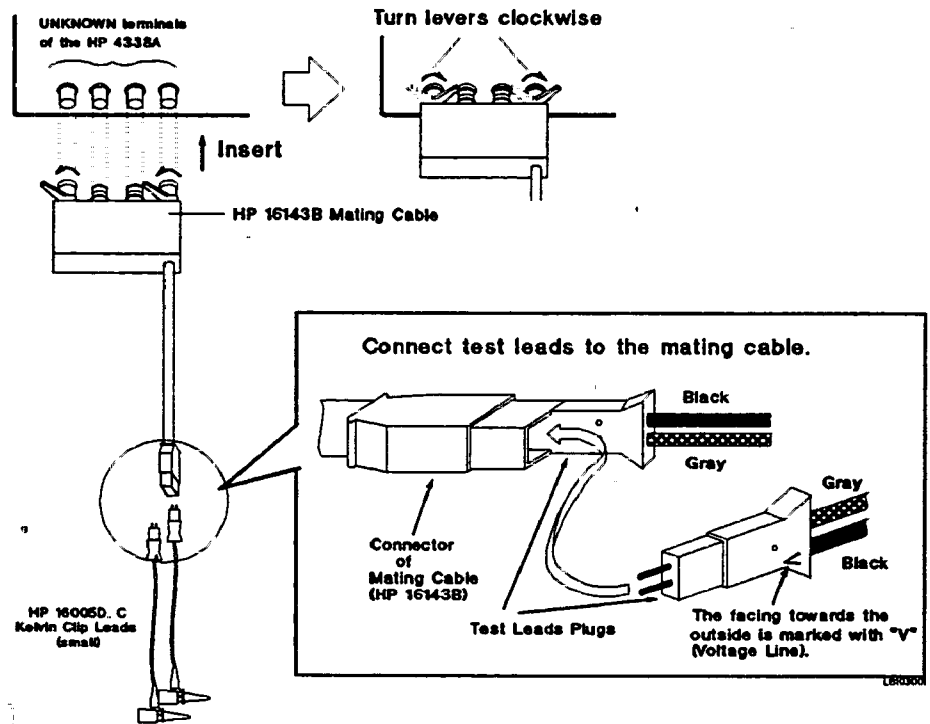

3. Perform a SHORT correction.

a. Short the test lead clips together as shown in the following figure:

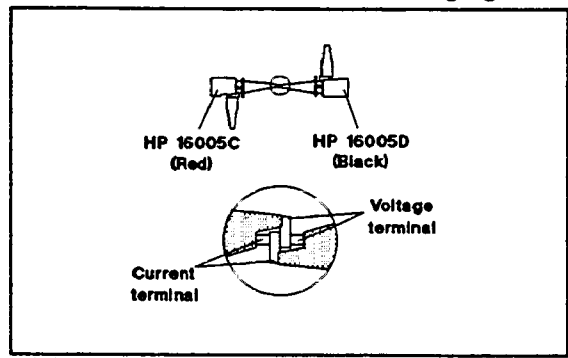

b. Press   .

SHORT CORRECTION

After a while, "CORR: COMPLETE" will be displayed, then the SHORT correction is completed. (If "OUT OF LIMIT" is displayed, see "Performing a SHORT Correction - Canceling the residual impedance in series with the DUT" in Chapter 2.)

4. Connect the DUT to the test fixture and the measurement result will be displayed. The following figure shows the typical measurement result display.

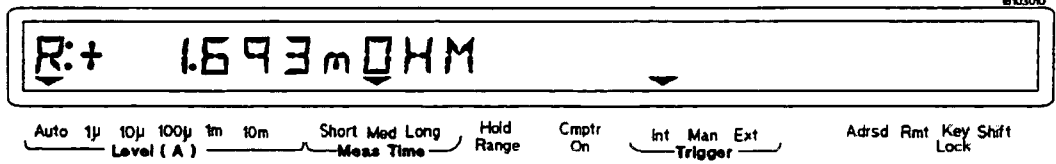

For More Information

- To print out the measurement result – See "To Print Measurement Data" in Chapter 2
- To select other measurement parameters – See "To Select Measurement Parameter" in Chapter 2
- To select measurement level – See "To Set Test Level" in Chapter 2

Evaluating Battery Internal Resistance

The HP 4338A's voltage protection on the UNKNOWN terminals allows you to evaluate internal resistance of a battery (42 V maximum).

The 1 kHz ac test signal is the best solution for evaluating the internal resistance of batteries because it avoids dc energy consumption.

Measuring a Battery Internal Resistance

DUT

Battery (≤ 42 V)

Requirements

Test Fixture : HP 16143B Mating cable
 HP 16006A Pin-type Probe Leads
 (use two leads)

Measurement Setup

Measurement parameter : R
 Measurement Range : Auto range mode
 Test level : 1 mA¹

¹ If the internal resistance of the battery is higher than 10 Ω , set the test level to 100 μ A, so as not to be OVLD (overload).^o

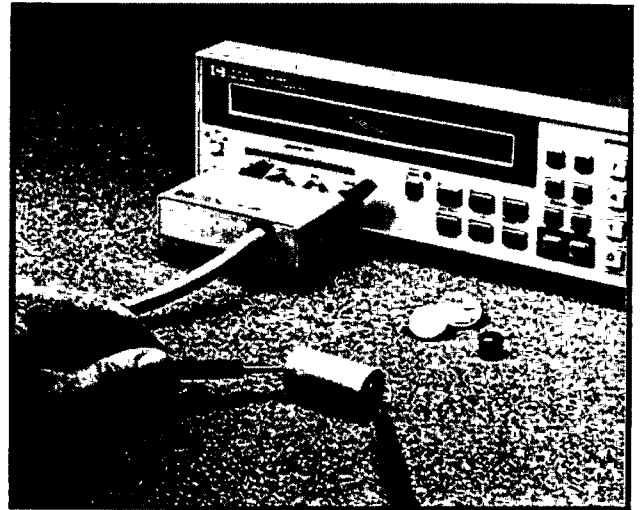

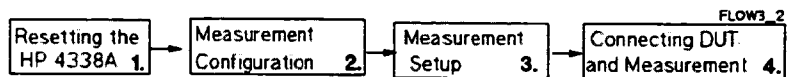

Measurement Procedure

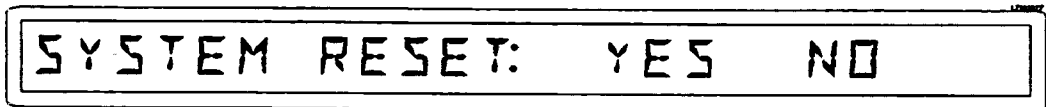

1. Reset the HP 4338A.

a. Press  .



b. Press  until YES blinks, and press .

2. Connect the test fixture to the UNKNOWN terminals.

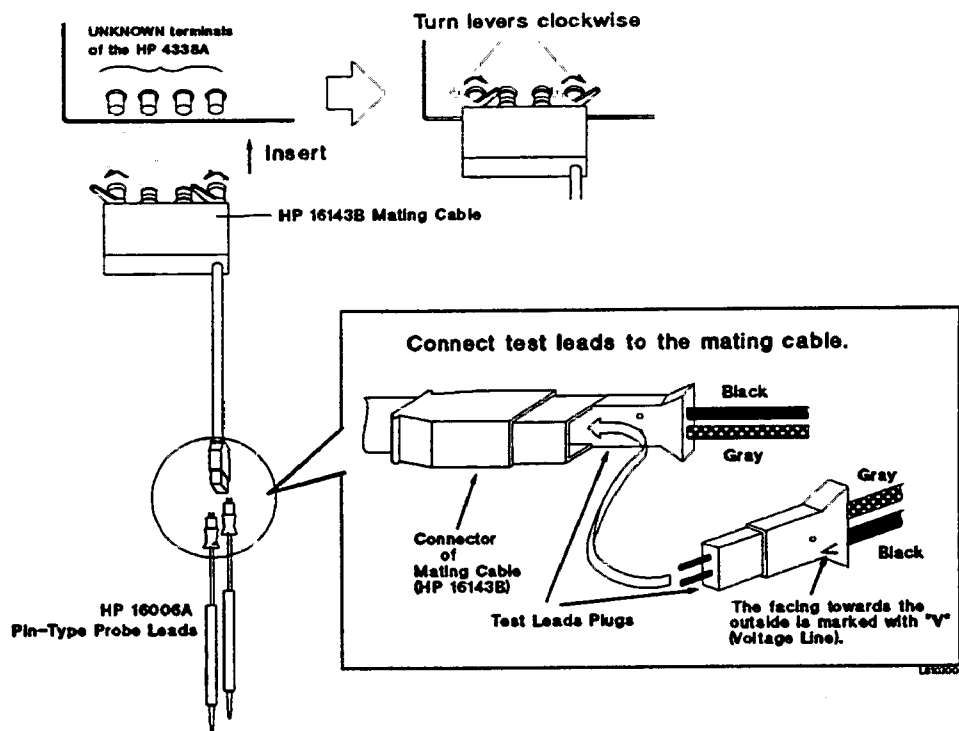

Note DO NOT perform a SHORT correction when using the HP 16006A Pin-type Probe.

3. Set the test level to 1 mA (or 100 μ A if $R_{DUT} > 10 \Omega$).

a. Press .

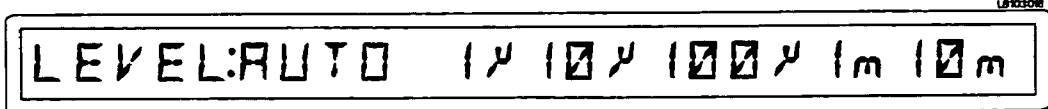

The blinking level is the level currently selected.

b. Press  until "1m"(or "100 μ " if $R_{DUT} > 10 \Omega$) is selected and press .

4. Connect the DUT and the measurement result is displayed. The following figure shows the typical measurement result display.

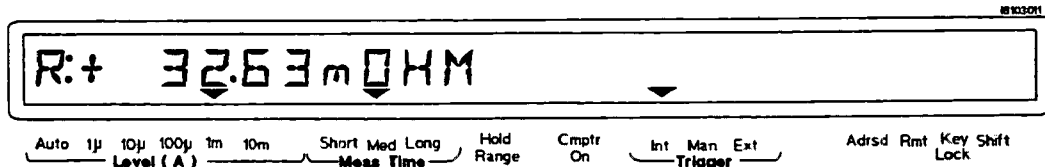

3-6 Measurement Examples

HP 4338A

For More Information

- To print out the measurement result — See “To Print Measurement Data” in Chapter 2
- To select other measurement parameters — See “To Select Measurement Parameter” in Chapter 2